

User manual

V2.0 EN | May 2022

 **EUROBOOR**
FOR PROFESSIONALS BY PROFESSIONALS



Air Die Grinder

ADG.2E



Congratulations on purchasing this Air Die Grinder. At EUROBOOR we strive to exceed our customers' expectations by developing and providing premium and innovative portable drilling and cutting solutions. We believe that a professional like you must be able to rely on a professional supplier. Which has led us to become a major player in the industrial world, with our own factory and several offices worldwide. All because we have always listened to our customers and to the demands from the market.

Our vision is focused on developing innovative portable tools that add value for our customers and facilitate them in their daily work. We never lose sight of sustainability, time savings and cost savings.

Enjoy your new machine!

Before operating your new Air Die Grinder, please first read all instructions. You find the instructions in this manual and on the warning label on your machine. With proper use, care and maintenance your machine will provide you with years of premium grinding performance.

**TO REDUCE THE RISK OF INJURY USER MUST READ AND UNDERSTAND ALL
INSTRUCTIONS**

To view all our offices and their contact information please visit: www.euroboor.com

The original manual has been produced in the English language. If any discrepancies should occur in translations, reference must be made to the original version for clarification.

Table of contents

1. Safety	3
1.1 General safety instructions	3
1.2 Specific safety instructions	7
1.3 Kickback and related warnings	12
2. Description	14
2.1 Description and features	14
2.2 Box content.....	15
2.3 Serial number.....	15
2.4 Technical data.....	16
2.5 Symbols.....	17
2.6 Environmental	18
3. Assembly	19
3.1 Fitting the collet and grinding burr.....	19
4. Using the Air Die Grinder	20
4.1 Air supply system.....	20
4.2 Operating instructions	21
5. Maintenance	23
5.1 Oil daily	23
6. Troubleshooting	24
7. Exploded view & Parts list	25
7.1 exploded view.....	25
7.2 Parts list	25
8. Warranty and service	26
8.1 Warranty.....	26
8.2 Service.....	26
9. CE declaration of conformity	27

1. Safety

1.1 General safety instructions

Do not use this Air Die Grinder before you have thoroughly read and completely understood this manual, specifically the “General safety instructions” and “Specific safety information”, including the figures, specifications, safety regulations and the signs indicating DANGER, WARNING and CAUTION.



WARNING: *When using the Air Die Grinder, basic safety precautions should always be followed to reduce the risk of electrical shock, fire and personal injury.*

Please also observe the relevant national industrial safety regulations. Non-observance of the safety instructions can lead to an electric shock, burns and/or severe injuries.

This manual should be kept for later use and enclosed with the Air Die Grinder, should it be passed on or sold.

Work area

1. Keep your work area clean and well lit. Cluttered and dark work areas increase the chance of accidents;
2. Do not operate Air Die Grinder in explosive atmospheres, such as in the presence of flammable liquids, gases or dust. Sparks could come off the workpiece which could ignite the dust or fumes.
3. Keep bystanders, children and visitors away while operating an Air Die Grinder. Distractions can cause you to lose control.

Personal safety

1. Stay alert, watch what you are doing and use common sense when using the Air Die Grinder. Do not use it while tired or under the influence of drugs, alcohol, or medication. A moment of inattention while operating the Air Die Grinder may result in serious personal injury.
2. Dress properly. Do not wear loose clothing or jewelry. Keep your hair, clothing and gloves away from moving parts. Loose clothes, jewelry, or long hair can be caught in moving parts.
3. Avoid accidental starting. Be sure that the on-/off- trigger is not pressed when plugging in the Air Die Grinder to the air supply. Carrying or plugging in the Air Die Grinder with your hands on the trigger increases the chance of accidents.
4. Never place hands, fingers, gloves or clothing near rotating tool parts.
5. Remove adjusting keys or wrench before starting the Air Die Grinder. A wrench or a key that is left attached to a rotating part of the Air Die Grinder may result in personal injury.
6. Do not overreach. Keep proper footing and balance at all times. This enables better control of the Air Die Grinder in unexpected situations.
7. Use safety equipment. Always wear eye protection. Dust mask, non-skid safety shoes, hard hat and hearing protection must be used for optimal safety.
8. If devices are provided for the connection of dust extraction and collection facilities, ensure these are connected and properly used. Use of dust collection can reduce dust-related hazards.



WARNING: *Wear ear and eye protection when using this power tool.*

Air Die Grinder use and care

1. Do not force the Air Die Grinder. Use the correct tool for your application. The correct tool will do the job better and safer at the rate for which it is designed.
2. Do not use the Air Die Grinder when the trigger does not turn it on or off. Any tool that cannot be controlled is dangerous and must be repaired.
3. Disconnect the air supply before making any adjustments, changing accessories, or storing the Air Die Grinder. Such preventive safety measures reduce the risk of starting the tool accidentally.
4. Store your Air Die Grinder out of reach for children and other untrained persons. Air Die Grinders are dangerous in the hands of untrained users.
5. Maintain the Air Die Grinder with care. Check for misalignment of moving parts, breakage of parts and any other condition that may affect the Air Die Grinder's operation. If you detect damage, have the Air Die Grinder serviced before use. Many accidents are caused by poorly maintained tools.
6. Keep cutting tools sharp and clean. Properly maintained cutting tools with sharp cutting edges are less likely to bind and are easier to control.
7. Only use accessories that are recommended by EUROBOOR for your Air Die Grinder. Accessories that are suitable for one tool may become hazardous when used on another tool.
8. Use the Air Die Grinder, accessories and tool bits etc. in accordance with these instructions and in the manner intended for the particular type of tool, taking into account the working conditions and the work to be performed. Use of the tool for operations different from intended could result in a hazardous situation.

Service

1. Service must be performed only by qualified repair personnel. Service or maintenance performed by unqualified personnel could result in risk of injury.
2. When servicing a tool, use only identical replacement parts. Follow instructions in the maintenance section of this manual. Use of unauthorised parts or failure to follow maintenance instructions may create a risk of injury.



WARNING: *Remove the air supply from the machine before carrying out any installation, adjustment, servicing or maintenance.*

Residual risk

In spite of following the relevant safety regulations and their implementation, every tool involves a certain residual risk which cannot be completely excluded by safety mechanisms. Power tools must therefore always be operated with caution!

1.2 Specific safety instructions





WARNING: This tool is intended to function as a grinder. Read all safety warnings, instructions, illustrations and specifications provided with this tool. Failure to follow all instructions listed below may result in electrical shock, fire and serious injury.

RISK OF EYE OR HEAD INJURY	
WHAT COULD HAPPEN	HOW TO PREVENT IT
<ul style="list-style-type: none"> - Air powered equipment and power tools are capable of propelling materials such as fasteners, metal chips, sawdust and other debris at high speed which could result in serious eye injury. 	<ul style="list-style-type: none"> - Always wear safety glasses - Never leave operating tool unattached. Disconnect air hose when tool is not in use.
<ul style="list-style-type: none"> - Compressed air can be hazardous. The air system can cause injury to soft tissue areas such as eyes, ears, etc. Particles or objects propelled by the stream can cause injury. 	<ul style="list-style-type: none"> - For additional protection use an approved face shield in addition to safety glasses.
<ul style="list-style-type: none"> - Tool attachments can become loose or break and fly apart propelling articles at the operator and others in the work area. 	<ul style="list-style-type: none"> - Make sure that any attachments are securely assembled.

RISK OF FIRE OR EXPLOSION	
WHAT COULD HAPPEN	HOW TO PREVENT IT
<ul style="list-style-type: none"> - Abrasive tools such as sanders and grinders, rotating tools such as drills, and impact tools such as nailers, staplers, wrenches, hammers and reciprocating saws are capable of generating sparks, which could result in ignition of flammable materials. 	<ul style="list-style-type: none"> - Never operate tools near flammable substances such as gasoline, naphtha, cleaning solvents, etc. - Work in a clean, well-ventilated area free of combustible materials. - Never use oxygen, carbon dioxide or other bottled gases as a power source for air tools.

<ul style="list-style-type: none"> - Exceeding the maximum pressure rating of tools or accessories could cause an explosion resulting in serious injury. 	<ul style="list-style-type: none"> - Use compressed air regulated to a maximum pressure at or below the rated pressure of any attachments. - Never connect to an air source that is capable of exceeding 200 psi. - Always verify prior to using the tools that the air source has been adjusted to the rated air pressure range.
---	--

RISK OF LOSS OF HEARING	
	
WHAT COULD HAPPEN	HOW TO PREVENT IT
<ul style="list-style-type: none"> - Long term exposure to noise produced from the operation of air tools can lead to permanent hearing 	<ul style="list-style-type: none"> - Always wear ear protection.

INHALATION HAZARD	
	
WHAT COULD HAPPEN	HOW TO PREVENT IT
<ul style="list-style-type: none"> - Abrasive tools, such as grinders, sanders and cut-off tools generate dust and abrasive materials, which can be harmful to human lungs and respiratory system. 	<ul style="list-style-type: none"> - Always wear properly fitting facemask or respirator when using such tools.
<ul style="list-style-type: none"> - ° Some materials such as adhesives and tar contain chemicals whose vapours could cause serious injury with prolonged exposure. 	<ul style="list-style-type: none"> - Always work in a clean, dry, well-ventilated area.

RISK OF INJURY	
	
WHAT COULD HAPPEN	HOW TO PREVENT IT
<ul style="list-style-type: none"> - A tool left unattended, or with the air hose attached, can be activated by unauthorized persons leading to their injury or injury to others. 	<ul style="list-style-type: none"> - Remove air hose when tool is not in use and store tool in secure location away from reach of children. and untrained users.
<ul style="list-style-type: none"> - Air tools can propel fasteners or other materials throughout the work area. 	<ul style="list-style-type: none"> - Use only parts, fasteners and accessories recommended by the manufacturer. - Keep work area clean and free of clutter. Keep children and others away from tool while it is in operation. - Keep work area well lit.
<ul style="list-style-type: none"> - A wrench or a key that is left attached to a rotating part of the tool increases the risk of personal injury. 	<ul style="list-style-type: none"> - Remove adjusting keys and wrenches before turning the tool on.

<ul style="list-style-type: none"> - Using inflator nozzles for duster applications can cause serious injury. 	<ul style="list-style-type: none"> - DO NOT use inflator nozzles for duster applications.
<ul style="list-style-type: none"> - Air tools can become activated by accident during maintenance or tool changes. 	<ul style="list-style-type: none"> - Remove air hose to lubricate or add grinding attachments, sanding discs, drills, etc. to the tool. - Never carry the tool by hose. - Avoid unintentional starting. Don't carry hook-up tool with finger on trigger. - Only an authorized service representative should do repair servicing.
<ul style="list-style-type: none"> - Air tools can cause the workpiece to move upon contact: leading to injury. 	<ul style="list-style-type: none"> - Use damps or other devices to prevent movement.
<ul style="list-style-type: none"> - Loss of control of the tool can lead to injury to self or others. 	<ul style="list-style-type: none"> - Never use tool while using drugs or alcohol. - Don't overreach. Keep proper footing and balance. - Keep handles dry, clean and free from oil/grease. - Stay alert. Watch what you are doing, Use common sense. Do not operate tool when you are tired.
<ul style="list-style-type: none"> - Poor quality, improper or damaged tools such as grinding wheels, chisels, sockets, drills, nailers, staplers, etc., can fly apart during operation, propelling particles throughout the work area causing serious injury. 	<ul style="list-style-type: none"> - Always use tool attachment rated for the speed of the power tool. - Never use tools, which have been dropped, impacted or damaged by use. - Use only impact grade sockets on an Impact wrench. - Do not apply excessive force to the tools; let the tool perform the work.
<ul style="list-style-type: none"> - Fasteners could ricochet or be propelled causing serious injury or property damage: 	<ul style="list-style-type: none"> - Never point discharge of tool at self or others. - Do not pull trigger unless tool contact safety device is against work surface. - Never attempt to drive fasteners into hard surfaces such as steel, concrete, or tile. - Avoid driving a fastener on top of another fastener. - Position tool carefully so that fasteners will be delivered to the proper location.
<ul style="list-style-type: none"> - Improperly maintained tools and accessories can cause serious injury. 	<ul style="list-style-type: none"> - Maintain the tool with care. - Keep a cutting tool sharp and clean. A properly maintained tool, with sharp cutting edges, reduces the risk of binding and is easier to control.

- There is a risk: of bursting if the tool is damaged.	- Check for misalignment or binding of moving parts, breakage of parts and any other condition that affects the tool's operation. If damaged, have the tool serviced before using.
- Use only accessories identified by the manufacturer to be used with specific tools.	- Use of an accessory not intended for use with the specific tools increase the risk of injury to persons.

RISK OF ELECTRIC SHOCK	
	
WHAT COULD HAPPEN	HOW TO PREVENT IT
- Using air tools to attach electrical wiring can result in electrocution or death.	- Never use nail/staplers to attach electrical wiring while energized.
- This tool is not provided with an insulated gripping surface. Contact with a "live" wire will also make exposed metal parts of the tool "live" and can result in electrocution or death.	- Avoid body contact with grounded surfaces such as pipes, radiators, ranges and refrigerators. There is an increased risk of electric shock if your body is grounded.
- Fasteners coming in contact with hidden electrical wiring could cause electrocution or death.	- Thoroughly investigate the workpiece for possible hidden wiring before performing work.

RISK OF ENTANGLEMENT	
	
WHAT COULD HAPPEN	HOW TO PREVENT IT
- Tools which contain moving elements, or drive other moving parts, such as grinding wheels, sockets, sanding discs, etc., can become entangled in hair, clothing, jewelry and other loose objects, resulting in severe injury.	- Never wear loose fitting clothes or apparel that contains loose straps or ties, etc., which could become entangled in moving parts of the tools. - Remove any jewelry, watches, identifications, bracelets, necklaces, etc., which might become caught by the tool. - Keep hands away from moving parts. Tie up or cover long hair. - Always wear proper fitting clothing and other safety equipment when using the tool.

RISK OF CUT OR BURNS		
WHAT COULD HAPPEN	HOW TO PREVENT IT	
<ul style="list-style-type: none"> - Tools that cut, shear, drill, staple, punch, chisel, etc. are capable of causing serious injury. 	<ul style="list-style-type: none"> - Keep the working part of the tool away from hands and body. 	

Other specific safety instructions

- Replace warning labels if they become obscured or removed.
- Do not use this tool for other than its intended use.
- Excessive air pressure or too much free rotation will decrease the life of the tool and may cause a hazardous situation.
- Check air hose for wear, and keep them away from heat and sharp edges. Do not carry the tool by the air hose.
- Slip / trip / fall is a major cause of serious injury or even death. Be aware of excess hose left on your walking way or on the working surface and be aware of the whipping air hose too.
- Continuous operation and bad working condition will injure hands. Once hand numbs or aches, operator shall stop the tool for a while for relaxing and re-start the work after recovery. Operator shall immediately see a doctor if such a serious symptom occurs.
- Keep visitors a safe distance from the work area. keep children away.
- This product may contain one or more chemicals known to cause cancer and birth defects or other reproductive harm. Wash hands after handling.

1.3 Kickback and related warnings

Kickback is a sudden reaction to a pinched or snagged grinding accessory. Pinching or snagging causes rapid stalling of the grinding accessory which in turn causes the uncontrolled grinding tool to be forced in the direction opposite of the accessory's rotation at the point of the binding.

For example, if a rotary burr is snagged or pinched by the workpiece, the edge of it that is entering into the pinch point can dig into the surface of the material causing the rotary burr to climb out or kick out. The rotary burr may either jump toward or away from the operator, depending on direction of its movement at the point of pinching.

Kickback is the result of grinding tool misuse and/or incorrect operating procedures or conditions and can be avoided by taking proper precautions as given below:

1. Maintain a firm grip on the grinding tool and position your body and arm to allow you to resist kickback forces.
2. Always operate the machine using two hands, for maximum control over kickback or torque reaction during start-up. The operator can control torque reactions or kickback forces, if proper precautions are taken.
3. When using rotary burrs or other grinding accessories, always have the workpiece securely clamped. These grinding accessories will grab if they become slightly canted in the groove, and can kickback. When a rotary burr grabs, it may jump from the groove and you could lose control of the grinder.
4. Never place your hand near the grinding accessory. Accessory may kickback over your hand.

5. Do not position your body in the area where power tool will move if kickback occurs. Kickback will propel the tool in direction opposite to the accessory's movement at the point of snagging.
6. Use special care when working corners, sharp edges etc. Avoid bouncing and snagging the grinding accessory. Corners, sharp edges or bouncing have a tendency to snag the grinding accessory and cause loss of control or kickback.
7. Do not attach a saw chain woodcarving blade or toothed saw blade. Such blades create frequent kickback and loss of control.

2. Description

2.1 Description and features



[Image 2-1]

1. Collet nut
2. Spindle
3. Shaft (150 mm)
4. On- / off- trigger
5. Air regulator
6. Exhaust deflector

2.2 Box content

Note: When unpacking, make sure the parts listed below are included. If missing or broken, please contact distributors as soon as possible.

1 x ADG.2E Air Die Grinder Extended

1 x Collet 6 mm (or 1/4")

1 x Air connector type EURO 1/4"

1 x Air connector type ORION 1/4"

1 x Air connector type ISO B 1/4"

1 x Wrench 16 mm

1 x Wrench 19 mm

1 x User manual

2.3 Serial number

The serial number is mentioned on the power tool two times: on the serial no. sticker on the Air Die Grinder shell and box. The serial number will help you, your dealer and EUROBOOR to validate and identify the power tool.

For example:

210701001







Breaks down to:

21	07	01	001
Year	month- of manufacture	date- of manufacture	Identification- number

2.4 Technical data

ADG.2E	Metric	Imperial
Collets	6 mm	1/4"
Air inlet	∅ 6.35 mm	1/4"
Air hose	∅ 9.525 mm	3/8"
Connector type	Euro, Orion, ISO B	
Avg. Air consumption	5 SCFM	
Working pressure	6.3 bar	90 PSI
No-load speed	Max. 22000 rpm	
Weight	1.31 kg	2.89 Lbs
Length	338 mm	13 5/16"
Height	70 mm	2 3/4"

2.5 Symbols

Symbol	Term, meaning	Explanation
	Read documentation	Be sure to read the documentation in this user manual and specifically the “General safety instructions” and “Specific safety information”.
	Wear ear protection	Use ear protection during operation.
	Wear eye protection	Use eye protection during operation.
	Danger/Warning/Caution	Read and apply the information in the adjacent text!
	European conformity symbol	Confirms the conformity of the machine with the directives of the European Community.
	ISO9001	Certified in accordance with ISO9001:2015 quality management system.
mm	Milimetre	Unit of measure for the dimensions.
“	Inch	Unit of measure for the dimensions.
Kg	Kilogram	Unit of measure for the mass.
Lbs	Pounds	Unit of measure for the mass.
Rpm	Revolutions per minute	Unit of measure for the revolutions.
SCFM	Standard cubic feet per minute	Unit of measure for air consumption.

2.6 Environmental



Separate collection. This product must not be disposed of with normal household waste.



Separate collection of used products and packaging allows materials to be recycled and used again. Re-use of recycled materials helps prevent environmental pollution and reduces the demand for raw materials.

Local regulations may provide for separate collection of electrical products from the household, at municipal waste sites or at the retailer when you purchase a new product.

3. Assembly



WARNING: *Switch off and unplug the Air Die Grinder from the air supply before assembling or adjusting the tool.*

3.1 Fitting the collet and grinding burr

1. A. Loosen the collet nut by using the supplied wrenches.
B. After loosening the collet nut, place the collet (6mm or 1/4") inside.
C. Put the collet nut back in place, but do not tighten it yet.
2. Insert the grinding burr into the collet. Make sure to insert at least 25% of the grinding burr's shank into the collet.
3. Tighten the collet nut using the supplied wrenches. Make sure the collet nut is tightened well and the grinding burr is stuck in place.



Step 1
(A, B and C)



Step 2



Step 3

4. Using the Air Die Grinder

4.1 Air supply system

For using this tool the following air supply system layout is recommended:

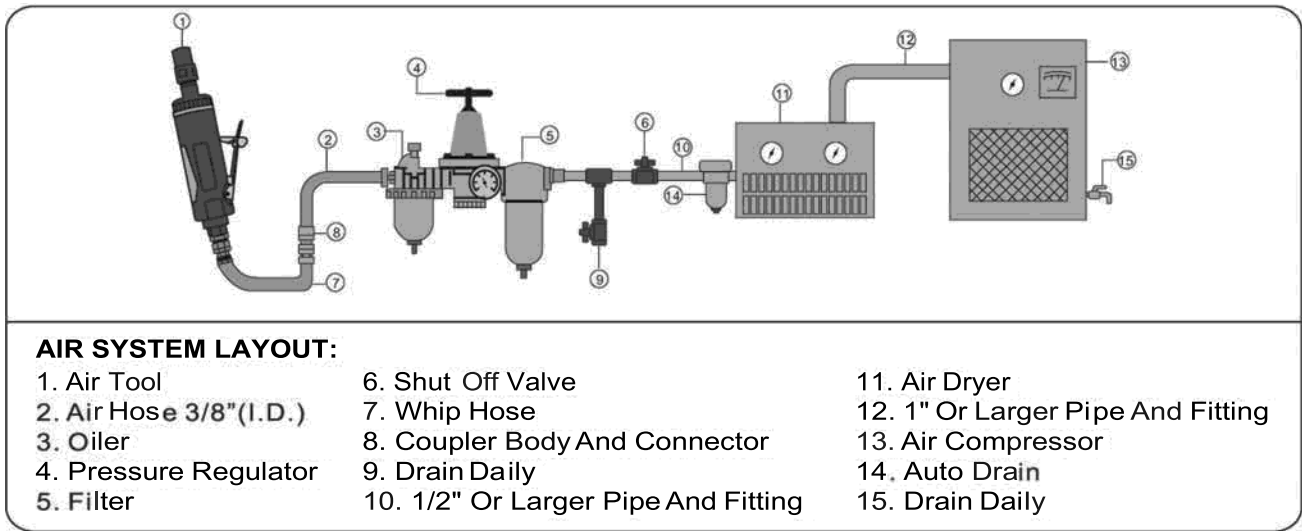

Also **take note** of the following:

1. Make sure that the air compressor being used for the air tool operation supplies the correct output (SCFM).
2. Have the tool in the "off" position when connecting the tool to the air supply.
3. Use 90 PSI / 6.3 Bar air pressure while running the tool. Using a different air pressure may result in reduced performance of the grinder.
4. Drain water from the air compressor tank daily together with any condensed water in the air hoses. Water in the air supply system can result in reduced performance and/or damage.
5. Clean the air inlet filter weekly. Unclean air can result in reduced performance, faster wear and/or damage.

6. The minimum hose diameter should be 1/4" I. D. and the fittings should have the same inside dimensions. But usually a 3/8" I.D. air hose is recommended for air supply to get the best function of air tool operation.
7. Use proper hoses and fittings. We do not suggest connecting quick change couplings directly to the tool since they may cause failure due to vibration. Instead, add a leader hose and connect coupling between air supply and hose whip.
8. Check hoses for wear before individual use. Make certain that all connections are in security.

4.2 Operating instructions

For operating the tool, please follow the steps below.



WARNING: Make the die grinder run idle for at least 30 seconds with the grinding accessory correctly assembled, the grinding accessory should be immediately replaced if there is the vibration. Only use the grinding accessory with shank that match the installed collet. Smaller shank will not be secure and could become loose during operation.

1. Lubricate the tool before operating. Please refer to "5. Maintenance".
2. Prepare the tool, inserting the collet and grinding burr, as described in "3.1 Fitting the collet and grinding burr"



WARNING: Only use grinding accessories that have an RPM rating equal to or greater than the tool itself.

3. Insert one of the supplied air nipples that fits with the air coupling that will be used for working with the tool.
4. Connect the air supply hose to the tool. Make sure the air coupling is set in place and no air is leaking.

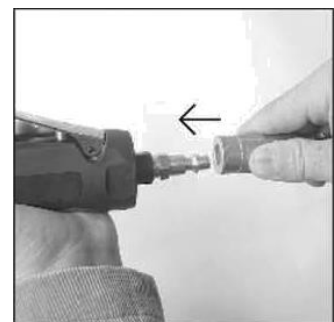

5. Before working the tool make sure the air flow adjustment knob is set in the right position. (1 = minimum speeds, 4 = maximum speed)



6. Once the air connection is in place and the correct air flow rate has been chosen, the tool is ready to be operated. Operating the part can be done by pressing the trigger-block forward. Once the trigger is pressed air will make the grinding burr rotate on high speed. **KEEP CLEAR THE ROTATING GRINDING BURR WITH HANDS, CLOTES, HAIR OR ANY OTHER LOOSE OBJECTS.**

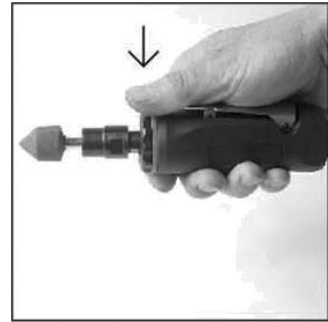

7. After finishing the workpiece: Disconnect the air supply and remove the grinding burr to avoid injuries coming from sharp edges.

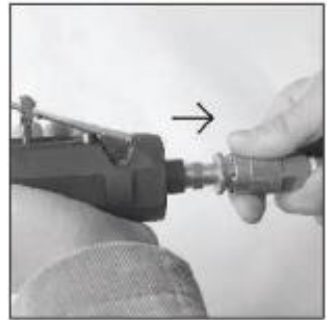

WARNING: *excessive pressure exercised on grinder may lead to high working power and overload. It increases the wear on the rotary burr or other grinding accessory and can damage the motor of the die grinder.*



WARNING: *Sparks generated when grinding metal. Take care that no combustible material presented on the area of flying sparks.*

5. Maintenance

Your EUROBOOR Air Die Grinder has been designed to operate over a long period of time. Continuous satisfactory operation depends upon proper tool care and regular cleaning.



WARNING: *To reduce the risk of injury, turn the grinder off and disconnect machine from the air supply before installing and removing accessories, before adjusting or changing set-ups or when making repairs. An accidental start-up can cause injury.*

Just as every tool with moving parts, your EUROBOOR Air Die Grinder also needs regular maintenance service. A few recommendations follow:

- Oil daily
- Regularly inspect all mountings and screws and ensure they are properly tightened. Should any of the screws be loose, tighten them immediately. Failure to do so may result in serious damage.
- Consult the authorised service agent about the event of failure.
- Clean the tool after each use.

5.1 Oil daily

The tool should be lubricated daily (or before each use) with air tool oil (not included). During continuous operation, the tool should be oiled every 1 to 2 hours. For lubricating the Air Die Grinder EUROBOOR offers pneumatic oil IBO.80.

For lubricating it is recommended to use 4 to 5 drops of oil in the air inlet. After which 30 seconds of running is required to distribute the oil through the tool.

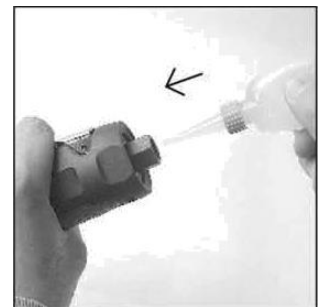

6. Troubleshooting

Problem	Possible Cause	Corrective Action
<p>Tool runs slowly or will not operate</p>	<p>No oil in tool. Low air pressure. Air hose leaks. Pressure drops Moisture blowing out of tool exhaust. Worn rotor blade.</p>	<p>Lubricate the tool with EUROBOOR pneumatic oil IBO.80.</p> <p>Adjust the compressor regulator to tool maximum of 90 PSI and/or Adjust the regulator on the tool to maximum setting.</p> <p>Check the air hose for possible leaks and repair these.</p> <p>Be sure the hose is the proper size.</p> <p>Do not use a multiple number of hoses connected together with quick-connect fittings.</p> <p>Water in tank: drain tank. Oil tool and run until no water is evident. Oil tool again and run 1-2 seconds.</p>
<p>Abnormal vibration and/or excessive heat</p>	<p>Improper lubrication.</p>	<p>Lubricate the tool with EUROBOOR pneumatic oil IBO.80.</p>

For any problems not in this troubleshooting table, contact your EUROBOOR distributor or sales agent from whom purchased the tool.

7. Exploded view & Parts list

7.1 exploded view

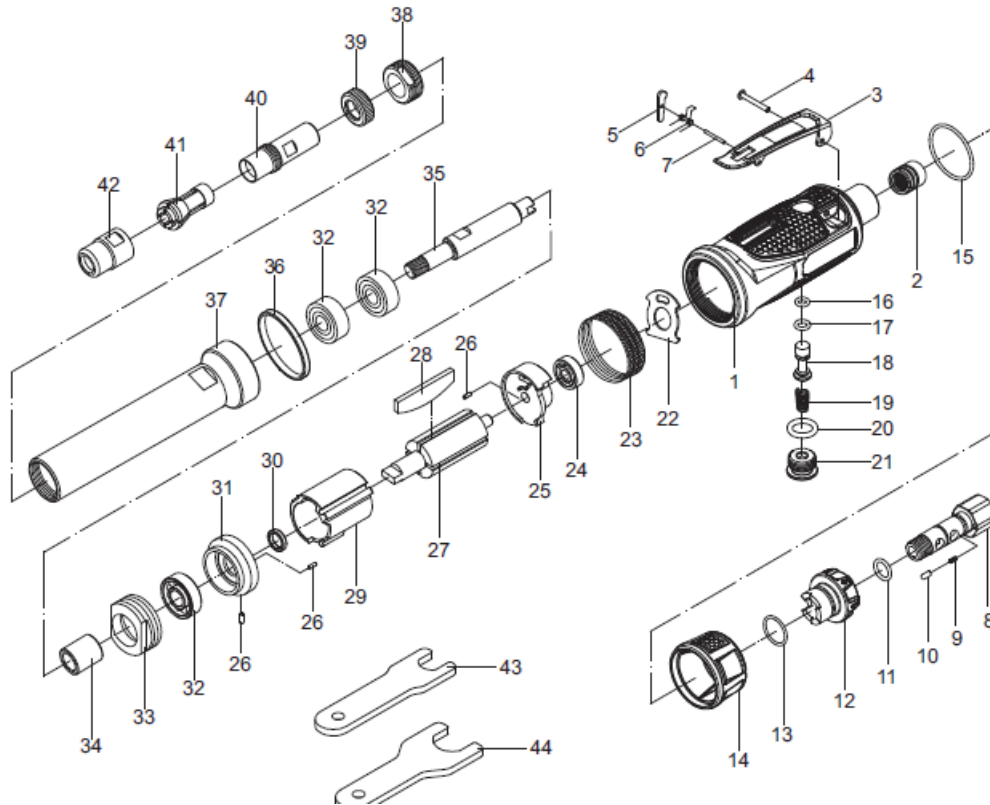

7.2 Parts list

Part No.	Description	Qty.	Part No.	Description	Qty.
01	Main housing	1	23	Bushing	1
02	Bushing	1	24	Bearing	1
03	Trigger	1	25	Rear plate	1
04	Bolt	1	26	Bolt	3
05	Lever block	1	27	Rotor	1
06	Spring	1	28	Rotor blade	4
07	Bolt	1	29	Cylinder	1
08	Air inlet nipple	1	30	Bushing	1
09	Spring	1	31	Front plate	1
10	Pin	1	32	Bearing	3
11	O-ring	1	33	Screw ring	1
12	Air regulator	1	34	Bushing	1
13	O-ring	1	35	Work spindle	1
14	Exhaust deflector	1	36	Decoration ring	1
15	O-ring	1	37	Shaft	1
16	O-ring	1	38	Fix ring	1
17	O-ring	1	39	Protective ring	1
18	Valve stem	1	40	Collet base	1
19	Spring	1	41	Collet	1
20	O-ring	1	42	Collet cap	1
21	Nut	1	43	Wrench (1)	1
22	Gasket	1	44	Wrench (2)	1

8. Warranty and service

8.1 Warranty

Euroboor B.V. warrants this Air Die Grinder to be free of material defects and workmanship errors under normal use for a period of 12 months after date of purchase.

8.2 Service

To maximise the lifetime of your EUROBOOR power tool always use service and parts from an official EUROBOOR distribution channel. Whenever in need of such, always contact original point of sales or if no longer existent the distributor of EUROBOOR products in your country.

9. CE declaration of conformity

EUROBOOR BV declares that the following appliance complies with the appropriate basic safety and health requirements of the EC guidelines based on its design and type, as brought into circulation by EUROBOOR BV.

Designation/function	Air Die Grinder
Brand	EUROBOOR
Types	ADG.2E
Ratings and principal	6.3 bar / 90 PSI
Characteristics	Power: Compressed air Max air pressure: 6.3bar (90PSI) Avg. air consumption: 5 SCFM
Speed	22.000 rpm
Applicable guidelines	2006/42/EC on machinery
Used standards:	EN ISO 11148-9:2011 on hand-held non-electric power tools

Zoetermeer, 23 november 2021

Albert Koster



Managing Director